

ATKINS

Thermocouple Instrument & Probe Catalog



PROBES



THERMOCOUPLE INSTRUMENTS



ACCESSORIES

Cooper
ATKINS®
Accuracy to the Highest Degree



COOPER-ATKINS CORPORATION

For over 126 years, Cooper-Atkins has been a leading manufacturer of innovative food safety solutions. We have a global reach and are a trusted resource for reliable, high-quality temperature, time and humidity instruments as well as wireless temperature monitoring. The company continues to meet the needs of its customers, by remaining focused on education and the promotion of important industry issues, and by providing the highest level of customer service and satisfaction.

Table of Contents	
Company & Product Information	2-3
EconoTemp™ Thermocouple Instruments	4
AquaTuff™ Thermocouple Instruments	4
AquaTuff™ Wrap&Stow™ Thermocouple Instruments	5
Standard Needle Probes	6
Heavy-Duty Needle Probes	7
High-Temperature Needle Probes	7
Fine-Tip Needle Probes	8
Vat Probes	8
Ambient/Air Probes	9
Surface Probes	10-11
Miscellaneous Probes	12
Replacement Probes for 350 Series Thermocouple Wrap&Stow™ Instruments	13
Connectors & Extension Cables	13
Probe Information	14
Warranty	15
Troubleshooting	15
Services	15
Accessories & Kits	16



Carol P. Wallace
President / CEO

“We will continue to provide our dedicated customers with affordable solutions for every temperature measurement challenge - from bi-metal pocket tests to hand-held thermocouple units to our high-tech wireless temperature monitoring systems. When foodservice professionals are faced with temperature challenges they will continue to look to Cooper-Atkins to provide solutions tailored to the needs of their business.”



Carol P. Wallace has been the President and CEO of Cooper-Atkins Corporation since 1994 and has been recognized by the WBENC for leading a successful and thriving woman-owned corporation. The WBENC is the largest third-party certifier of businesses owned, controlled, and operated by women in the U.S.





THE HIGHEST DEGREE OF...

Durability

The assurance or probability that an equipment, machine, or material will have a relatively long, continuous useful life, without requiring an inordinate degree of maintenance.

Accuracy

The degree of closeness of measurements of a quantity to that quantity's actual (true) value. It's the condition or quality of being true, correct, or exact; precision or exactness; correctness.

Versatility

Capable of adapting easily to perform various tasks in multiple locations.

35100-K AquaTuff™ Thermocouple Instrument

Easy twist-open battery hatch with highly durable O-ring prevents water, dirt, and dust from penetrating housing.



Includes (2) AAA batteries that provide 1800 hours of battery life. Reduces operating costs.

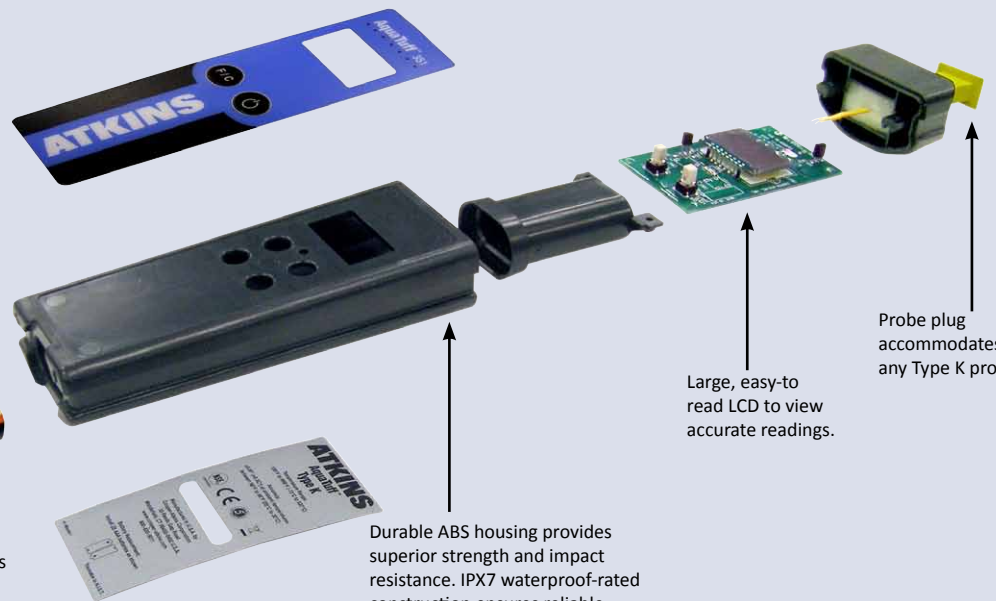

Durable ABS housing provides superior strength and impact resistance. IPX7 waterproof-rated construction ensures reliable performance even after immersion into liquids.

Large, easy-to-read LCD to view accurate readings.

Probe plug accommodates any Type K probe.

Durability

Our thermocouple instruments are used in harsh environments everyday. You need to be confident that your Atkins thermocouple will always work, even under the toughest conditions. Built from the finest electronic components and enclosed in a durable ABS housing, Cooper-Atkins' Thermocouple Instruments are guaranteed to be free of manufacturing or material defects in workmanship for a minimum of five years.



ECONOTEMP™ THERMOCOUPLE INSTRUMENTS

Removable rubber boot provides superior impact resistance. Withstands multiple drops from six feet onto a cement floor.



32311-K
EconoTemp™
Thermocouple
Instrument

	32311-K	32322-K
Temperature Range:	-40° to 500°F -40° to 260°C	-40° to 1000°F -40° to 538°C
Accuracy:	±2°F ±1°C	±1.0°F ±0.5°C
Resolution:	1°	0.1° up to 495°F / 257°C
Housing:	ABS Plastic	ABS Plastic
Hold:	No	No
Backlight:	No	No
Waterproof:	No	No
Power:	(3) 1.5V AAA	(3) 1.5V AAA
Battery Life:	4500 hours	1500 hours
Auto Off:	10 min.	10 min.
Weight:	6 oz / 170 g	6 oz / 170 g
Regulatory Listings:	CE NSF RoHS	CE RoHS
Warranty:	5 Year	5 Year

AQUATUFF™ THERMOCOUPLE INSTRUMENTS

	35100-K	35200-K
Temperature Range:	-100° to 999°F -73° to 537°C	-100° to 999°F -73° to 537°C
Accuracy:	±0.5°F ±0.3°C	±0.5°F ±0.3°C
Resolution:	0.1°	0.1° / 1° selectable
Housing:	ABS Plastic	ABS Plastic
Hold:	No	Yes
Backlight:	No	Yes
Waterproof:	Yes	Yes
Power:	(2) 1.5V AAA	(2) 1.5V AAA
Battery Life:	1800 hours	1800 hours
Auto Off:	10 min.	10 min.
Weight:	5 oz / 142 g	5 oz / 142 g
Regulatory Listings:	CE NSF RoHS	CE NSF RoHS
Warranty:	5 Year	5 Year



35100-K
AquaTuff™ Thermocouple
Instrument



35200-K
AquaTuff™ Thermocouple
Instrument



The non-Wrap&Stow™ instruments are compatible with any Type K thermocouple probe for maximum versatility. Thermocouple instruments and probes also available in Type J and T (see page 14)





Accuracy

The AquaTuff™ Total System Accuracy (instrument and probe accuracy combined) of 0.9°F (0.5°C) over the entire range is the result of rigorous testing. Using NIST-traceable equipment each individual instrument is tested against established standards. Once it meets our requirements, a *Certificate of Calibration* is issued with each instrument. Factory calibration services available for after-sales support.

AQUATUFF™ WRAP&STOW™ THERMOCOUPLE INSTRUMENTS

	35132 / N	35135	35140 / N	35232 / N	35235	35240 / N	35340
Temperature Range:	-100° to 500°F -73° to 260°C	-100° to 500°F -73° to 260°C	-100° to 500°F -73° to 260°C	-100° to 500°F -73° to 260°C	-100° to 500°F -73° to 260°C	-100° to 500°F -73° to 260°C	-100° to 500°F -73° to 260°C
Accuracy:	±0.9°F / ±0.5°C total system accuracy	±0.9°F / ±0.5°C*	±0.9°F / ±0.5°C total system accuracy	±0.9°F / ±0.5°C total system accuracy	±0.9°F / ±0.5°C*	±0.9°F / ±0.5°C total system accuracy	±0.9°F / ±0.5°C total system accuracy
Resolution:	0.1°	0.1°	0.1°	0.1° / 1° selectable	0.1° / 1° selectable	0.1° / 1° selectable	0.1°
Housing:	ABS Plastic	ABS Plastic	ABS Plastic	ABS Plastic	ABS Plastic	ABS Plastic	ABS Plastic
Hold:	No	No	No	Yes	Yes	Yes	No
Backlight:	No	No	No	Yes	Yes	Yes	No
Waterproof:	Yes	Yes	Yes	Yes	Yes	Yes	Yes
Power:	(2) 1.5V AAA	(2) 1.5V AAA	(2) 1.5V AAA	(2) 1.5V AAA	(2) 1.5V AAA	(2) 1.5V AAA	(2) 1.5V AAA
Battery Life:	1800 hours	1800 hours	1800 hours	1800 hours	1800 hours	1800 hours	1800 hours
Auto Off:	10 min.	10 min.	10 min.	10 min.	10 min.	10 min.	10 min.
Weight:	7 oz / 199 g	7 oz / 199 g	7 oz / 199 g	7 oz / 199 g	8 oz / 227 g	7 oz / 199 g	7 oz / 199 g
Regulatory Listings:	35132 CE RoHS 35132-N CE NSF RoHS	CE RoHS	35140 CE RoHS 35140-N CE NSF RoHS	35232 CE RoHS 35232-N CE NSF RoHS	CE RoHS	35240 CE RoHS 35240-N CE NSF RoHS	CE RoHS
Warranty:	5 Year	5 Year	5 Year	5 Year	5 Year	5 Year	5 Year

* Accuracy spec for instrument only. Surface probe temperature error for flat, clean, oiled surfaces with 2 lb (1 kg) pressure is typically within +3°F (+1.5°C) and -6°F (-3.5°C) without equipment thermostat cycling.



35132
AquaTuff™ Wrap&Stow™
Thermocouple Instrument
with DuraNeedle Probe



35235
AquaTuff™ Wrap&Stow™
Thermocouple Instrument
with Surface Probe

IPX7 Waterproof

The AquaTuff™ instruments are IPX7 waterproof rated and durable for harsh environments. An IPX7 level reading means that the instrument can be submerged in 1 meter of water for 30 minutes without water damage.



Easy twist-open
battery hatch.



Wrap&Stow™ probes can be
replaced at your location.
Refer to page 13 for
replacement probes.





Versatility

Each thermocouple instrument can be used in a variety of environments for multiple applications, by providing users with several probe options. Each probe is designed by Cooper-Atkins engineers, manufactured in our U.S. facility and built with high-temperature, abrasion-resistant cables. Probes are designed and built to the highest standards allowing for probe interchangeability with minimal impact on total system accuracy.

STANDARD INSERTION PROBES

Used to measure insertion and immersion temperatures of food products including solids, semi-solids and liquids. Rugged design for quick response and dependable performance.

<p>31901-K 1/8" Diameter Insertion Probe - Petite Handle</p>	<p>Temp. Range: -40° to 400°F (-40° to 205°C) Max Tip/Cable Temp: 400°F (205°C) Max Handle Temp: 300°F (149°C) Response Time: 4 seconds, liquid Unit Weight: 1 oz (28 g) Flexible Cable with Silicone Jacket</p>
<p>50335 / 39035 (J, K or T) 1/8" Diameter Insertion Probe</p> <p>Also available in 8" (302 mm) (50335-8K) and in 10" (254 mm) (50335-10K) shaft lengths.</p> <p>36" (914 mm) straight cable - only in 4.5" (114 mm) shaft version</p>	<p>50335 Temp. Range: -40° to 500°F (-40° to 260°C) Max Tip Temp: 500°F (260°C) Max Cable Temp: 176°F (80°C) Handle Temp: 280°F (138°C) Response Time: 4 seconds, liquid Unit Weight: 2 oz (57 g) Coiled Retractable Cable</p> <p>39035 Temp. Range: -40° to 400°F (-40° to 205°C) Max Tip/Cable Temp: 400°F (205°C) Unit Weight: 1 oz (28 g) Flexible Cable with FEP Jacket</p>
<p>50336 (J, K or T) 6" DuraNeedle Probe</p>	<p>Temp. Range: -40° to 500°F (-40° to 260°C) Max Tip Temp: 500°F (260°C) Max Cable Temp: 176°F (80°C) Max Handle Temp: 280°F (138°C) Response Time: 2 seconds, liquid Unit Weight: 2 oz (57 g) Coiled Retractable Cable</p>
<p>50337-K DuraNeedle - Direct Connect</p>	<p>Temp. Range: -100° to 500°F (-73° to 260°C) Max Tip Temp: 500°F (260°C) Response Time: 1 second, liquid Unit Weight: .5 oz (14 g)</p>
<p>50360-K Oven Insertion Probe</p>	<p>Temp. Range: -40° to 500°F (-40° to 260°C) Max Tip Temp: 500°F (260°C) Max Cable Temp: 600°F (316°C) Response Time: 2 seconds, liquid Unit Weight: 1 oz (28 g) Flexible Cable with Woven Stainless Steel Overbraid Can be left inserted in food product while cooking in an oven.</p>
<p>50361-K Armored Cable DuraNeedle Probe</p>	<p>Temp. Range: -40° to 400°F (-40° to 205°C) Max Tip/Handle/Cable Temp: 400°F (205°C) Response Time: 4 seconds, liquid Unit Weight: 6 oz (170 g) Flexible Armored Cable</p>



HEAVY-DUTY INSERTION PROBES

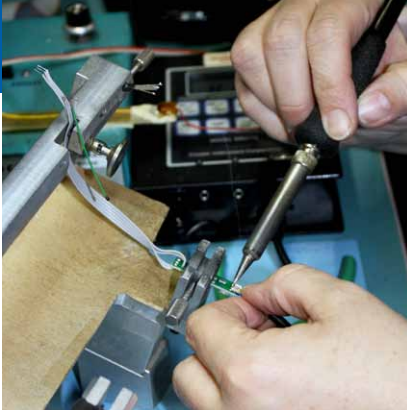

These rugged probes are designed for quick response where enhanced durability or a larger handle is desired. Foodservice applications include measuring frozen foods, solid or semi-solid meats. Industrial applications include high temperature measurements of dense materials such as asphalt.

Note: Do not use the probe as an ice pick. When measuring temperatures of solid products, it is always recommended to pre-drill the hole first, then insert the probe shaft.

50145 / 49135 (J, K or T) Rugged 1/8" Diameter Insertion Probe

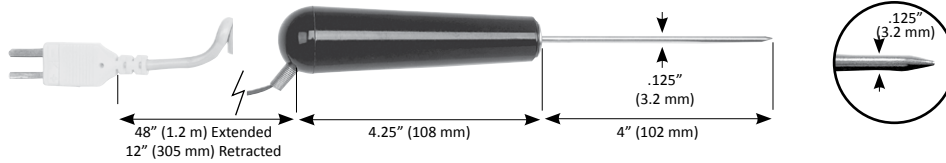

50145 - Coiled Cable

Temp. Range: -40° to 500°F (-40° to 260°C)
 Max Tip Temp: 500°F (260°C)
 Max Cable Temp: 176°F (80°C)
 Coiled Retractable Cable

49135 - Straight Cable

Temp. Range: -40° to 400°F (-40° to 205°C)
 Max Tip/Cable Temp: 400°F (205°C)
 Max Handle Temp: 325°F (163°C)
 36" (914 mm) straight cable
 Flexible Cable with FEP Jacket

Response Time: 4 seconds, liquid
 Unit Weight: 4 oz (113 g)

50101 (J, K or T) Frozen Product Probe

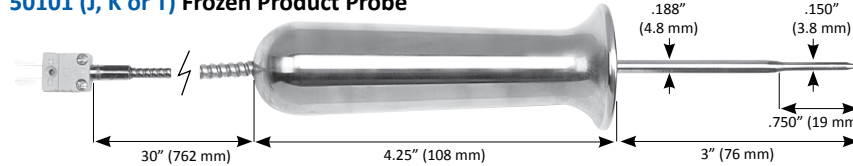

Temp. Range: -40° to 400°F (-40° to 205°C)
 Max Tip/Handle/Cable Temp: 400°F (205°C)
 Response Time: 4 seconds, liquid
 Unit Weight: 1 lb (454 g)
 Stainless Steel Handle and Flexible Armored Cable

Very heavy-duty with large handle grip enabling insertion into hard products.

50143 (J, K or T) Heavy Duty Insertion Probe

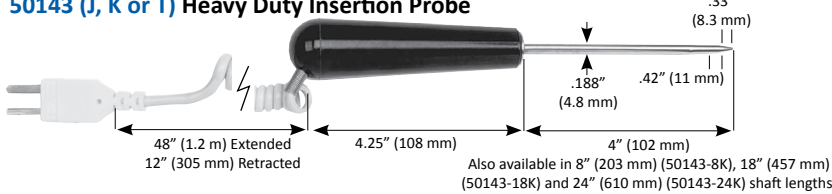

Temp. Range: -40° to 500°F (-40° to 260°C)
 Max Tip Temp: 500°F (260°C)
 Max Cable Temp: 176°F (80°C)
 Max Handle Temp: 325°F (163°C)
 Response Time: 5 seconds, liquid
 Unit Weight: 5 oz (142 g)
 Coiled Retractable Cable

HIGH-TEMPERATURE NEEDLE PROBES

Designed for insertion / immersion applications where high temperatures such as food, chemicals and melt temperatures for plastic molding are being measured.

Note: These probes are not recommended for use in highly acidic or alkaline products such as citrus and tomato products.

49127 (J, K or T) Reduced Tip - Direct Connect

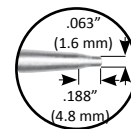
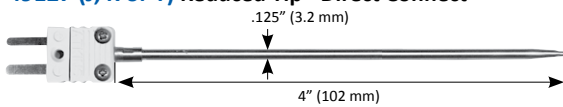

Temp. Range: 32° to 932°F (0° to 500°C)
 Max Tip Temp: 932°F (500°C)
 Response Time: 1 second, liquid
 Unit Weight: .5 oz (14 g)

50426 / 50427 (J, K or T) Reduced Tip Probe - 4" Stem / 12" Stem

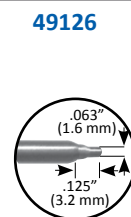
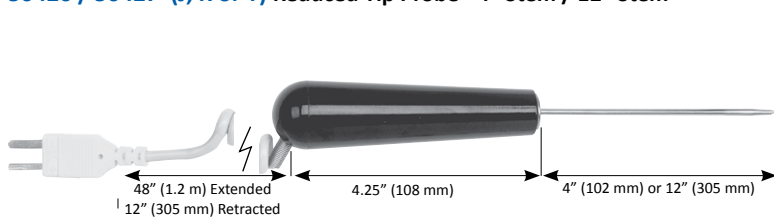

Temp. Range: 32° to 932°F (0° to 500°C)
 Max Tip Temp: 932°F (500°C)
 Max Cable Temp: 176°F (80°C)
 Max Handle Temp: 325°F (163°C)
 Response Time: 1 second, liquid
 Unit Weight: 5 oz (142 g)
 Coiled Retractable Cable

49126 (J, K or T) - Straight Cable

Max Cable Temp: 400°F (205°C)
 Unit Weight: 4 oz (113 g)
 36" (914 mm) straight cable
 Flexible Cable with FEP Jacket



FINE-TIP INSERTION PROBES



These insertion probes are designed to provide the quickest response with minimal impact on products. Ideal for small, semi-solid or liquid products such as hamburger patties, shrimp and mushrooms, or for sous-vide applications. Fine probe tips are fragile and should only be used by trained personnel. Use caution and avoid excessive force when inserting the probe.

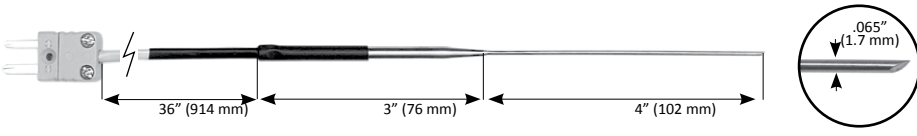
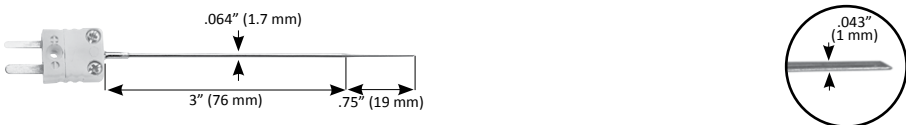
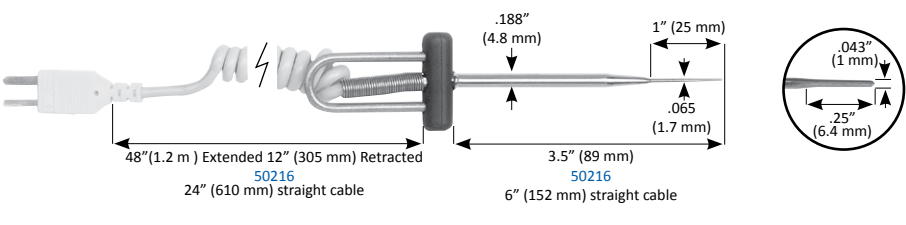
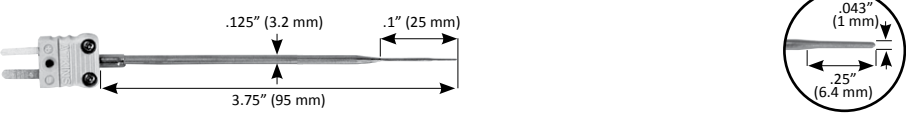
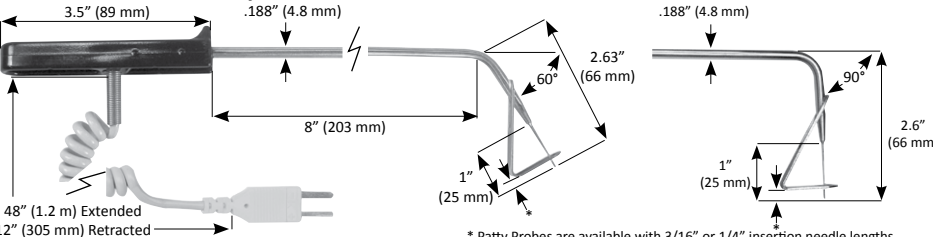

<p>49122 (J, K or T) Ultra Fine Product Probe - Chisel Tip</p> 	<p>Temp. Range: -100° to 500°F (-73° to 260°C) Max Tip Temp: 500°F (260°C) Max Cable Temp: 221°F (105°C) Response Time: 3 seconds, liquid Unit Weight: 1 oz (28 g) Flexible Cable with PVC Jacket Note: Do not use in highly acidic or alkaline products such as citrus and tomato products.</p>
<p>50207 (J, K or T) MicroNeedle - Chisel Tip - Direct Connect</p> 	<p>Temp. Range: -100° to 500°F (-73° to 260°C) Max Tip Temp: 500°F (260°C) Response Time: 1 second, liquid Unit Weight: .5 oz (14 g) Note: Do not use in highly acidic or alkaline products such as citrus and tomato products.</p>
<p>50209 (J, K or T)/ 50216 MicroNeedle - Rounded Tip</p> 	<p>50209- Coiled Cable Temp. Range: -100° to 500°F (-73° to 260°C) Max Tip Temp: 500°F (260°C) Max Cable Temp: 176°F (80°C) Max Handle Temp: 280°F (138°C) Response Time: 1 second, liquid Unit Weight: 2 oz (57 g) Coiled Retractable Cable</p> <p>50216- Micro Needle - Straight Cable Max Cable Temp: 400°F (205°C) Unit Weight: 1.5 oz (43 g) Flexible Cable with Fluoroelastomer Outer Jacket</p>
<p>50210-K MicroNeedle - Direct Connect</p> 	<p>Temp. Range: -100° to 500°F (-73° to 260°C) Max Tip Temp: 500°F (260°C) Response Time: 1 second, liquid Unit Weight: .5 oz (14 g)</p>
<p>50263-K / 50264-K Patty Probe</p>  <p>50293-K / 50294-K</p> <p>* Patty Probes are available with 3/16" or 1/4" insertion needle lengths.</p>	<p>50263-K / 50264-K 60° Angle 50293-K / 50294-K 90° Angle Temp. Range: -100° to 500°F (-73° to 260°C) Max Tip Temp: 500°F (260°C) Max Cable Temp: 176° (80°C) Max Handle Temp: 400°F (205°C) Response Time: 1 second, liquid Unit Weight: 3 oz (85 g) Coiled Retractable Cable</p>

VAT PROBES

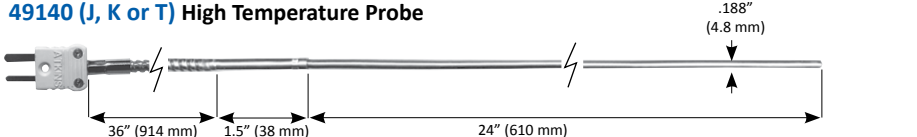
Designed for immersion temperatures and ideal for continuous monitoring of the cooking process. Ideal for monitoring deep fryers, large kettle cooking and vat temperatures.

<p>49140 (J, K or T) High Temperature Probe</p> 	<p>Temp. Range: 32° to 2012°F (0° to 1100°C) Max Tip Temp: 2012°F (1100°C) Max Cable Temp: 400°F (205°C) Response Time: 2 seconds, liquid Unit Weight: 6 oz (170 g) Flexible Armored Cable</p>
<p>50208 (J, K or T) Fry Vat Probe</p> 	<p>Temp. Range: -40° to 400°F (-40° to 205°C) Max Tip/Cable Temp: 400°F (205°C) Response Time: 8 seconds, liquid Unit Weight: 3 oz (85 g) Flexible Armored Cable</p>



AMBIENT / AIR PROBES



Suitable for measuring air temperatures. Some hand-held probes are designed to measure ambient air temperature, while other models monitor internal temperatures and include a clip for attaching the sensor inside freezers, coolers or ovens. Make sure to check each model for usage, recommendations and maximum temperature limits.

Note: Air has a low thermal conductivity and density which results in slower probe response times. To achieve a more rapid response in air temperature, wave the probe tip back and forth to create air motion across the probe tip.

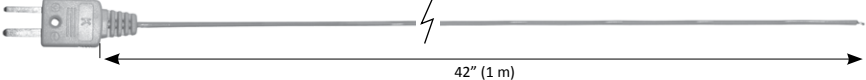
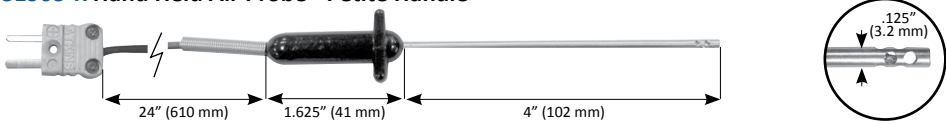
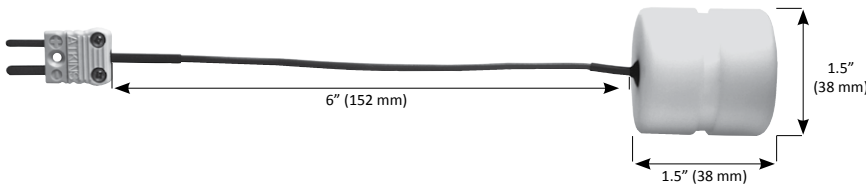
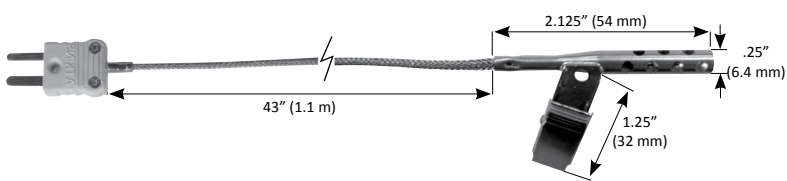
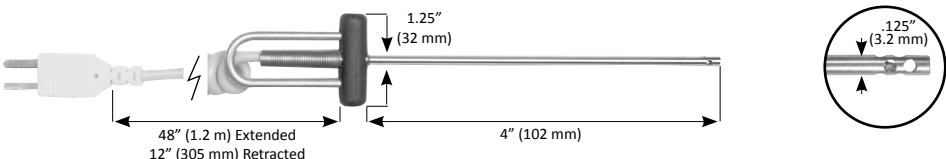
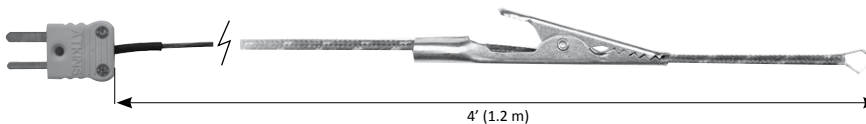
<p>6030MK Bead Probe</p> 	<p>Temp. Range: -100° to 500°F (-73° to 260°C) Max Tip/Cable Temp: 500°F (260°C) Response Time: .5 seconds in 5m/sec. air stream Unit Weight: .3 oz (8.5 g) Flexible FEP Outer Jacket</p>
<p>31903-K Hand Held Air Probe - Petite Handle</p> 	<p>Temp. Range: -40° to 400°F (-40° to 205°C) Max Tip/Cable Temp: 400°F (205°C) Max Handle Temp: 300°F (149°C) Response Time: 9 seconds in 5m/sec. air stream Unit Weight: 1 oz (28 g) Flexible Cable with Silicone Jacket</p>
<p>50248-K Thermocouple Solid Simulator Probe</p> 	<p>Temp. Range: -40° to 180°F (-40° to 82°C) Max Tip Temp: 180°F (82°C) Max Cable Temp: 400°F (204°C) Response Time: Up to 2 hours Unit Weight: 2.5 oz (71 g) Flexible Cable with FEP Jacket</p>
<p>50306-K / 50302 (J, K or T) Oven / Freezer Probe with Clip</p> 	<p>50306-K Temp. Range: -100° to 600°F (-73° to 316°C) Max Temp: 600°F (316°F) Response Time: 10 seconds in 5m/sec. air stream Unit Weight: 1 oz (28 g) Flexible Cable with Woven Stainless Steel Overbraid</p> <p>50302 Industrial Air Probe w/ Clip Temp. Range: 32° to 896°F (0° to 480°C) Max Tip/Cable Temp: 896°F (480°C) Cable Length: 46" (1.16 m) Flexible Cable with Fiberglass Jacket Note: Not recommended for use in foodservice.</p>
<p>50332 / 39302 (J, K or T) Hand Held Air Probe</p> 	<p>50332 - Coiled Cable Temp. Range: -100° to 500°F (-73° to 260°C) Max Tip Temp: 500°F (260°C) Max Cable Temp: 176°F (80°C) Handle Temp: 280°F (138°C) Response Time: 10 seconds in 5m/sec. air stream Unit Weight: 2 oz (57 g) Coiled Retractable Cable</p> <p>39302 Straight Cable Temp. Range: -328° to 400°F (-200° to 205°C) Max Tip/Cable Temp: 400°F (205°C) Response Time: 11 seconds in 5m/sec. air stream Cable Length: 36" (914 mm) Unit Weight: 1 oz (28 g) Flexible Cable with FEP Jacket</p>
<p>50338 (J, K or T) Industrial Air Probe with Alligator Clip</p> 	<p>Temp. Range: 32° to 896°F (0° to 480°C) Max Tip/Cable Temp: 896°F (480°C) Response Time: 9 seconds in 5m/sec. air stream Unit Weight: 1 oz (28 g) Flexible Cable with Fiberglass Jacket & Movable Clip. Note: Not recommended for use in foodservice.</p>

SURFACE PROBES



Suitable for measuring temperatures on a variety of surfaces. Griddles or grills should be checked frequently to ensure that proper cooking temperatures are maintained. Various types of equipment such as motors, pipes and plastic molds may also be monitored. Surface temperatures are the most difficult to measure accurately, especially on poor heat-conducting materials such as paper and some plastic films. It is not practical to estimate the temperature within a solid by measuring the surface temperature. The major source of error in reading surface temperature is obtaining adequate heat transfer from the surface into the measuring probe tip. To reduce this error: 1) use a small amount of oil or grease to improve heat transfer; 2) use a large contact area and 3) press the probe's tip's firmly against the measuring surface.

<p>4005MK Pipe Clamp Probe</p> <p>10' (3 m) 3" (76 mm)</p>	<p>Temp. Range: -20° to 300°F (-29° to 149°C) Max Tip Temp: 300°F (149°C) Max Cable Temp: 200°F (93°C) Response Time: 2 seconds, on pipe Unit Weight: 7 oz (198 g) Thermoplastic Elastomer Straight Cable, for Pipe Dimension of .25" to 1.375"</p>
<p>31907-K Surface Probe - Petite Handle</p> <p>24" (610 mm) 1.625" (41 mm) 4" (102 mm) .375" (10 mm)</p>	<p>Temp. Range: -40° to 400°F (-40° to 205°C) Max Tip/Cable Temp: 400°F (205°C) Max Handle Temp: 300°F (149°C) Response Time: 5 seconds, oiled surface Unit Weight: 1 oz (28 g) Flexible Cable with Silicone Jacket</p>
<p>50004-K Universal Holding Cabinet (UHC) Probe</p> <p>12" (305 mm) 4.25" (108 mm) 12" (305 mm) 1.25" (32 mm) 2.175" (55 mm)</p>	<p>Temp. Range: -40° to 300°F (-40° to 149°C) Max Tip Temp: 300°F (149°C) Max Cord Temp: 400°F (205°C) Response Time: 4 seconds on flat oiled surface Unit Weight: 6 oz (170 g) FEP Outer Jacket</p>
<p>50001 (J, K or T) Right Angle Bell Surface Probe</p> <p>30" (762 mm) 4.25" (108 mm) 9" (229 mm) 1.188" (30 mm) .67" (17 mm)</p>	<p>Temp. Range: -40° to 400°F (-40° to 205°C) Max Tip/Cable Temp: 400°F (205°C) Max Handle Temp: 325°F (163°C) Response Time: 7 seconds, oiled surface Unit Weight: 6 oz (170 g) Flexible Armored Cable Designed for use on any flat surface. Bell self-ori-ents to the surface, giving superior contact. Ideal for griddle and platens.</p>
<p>50008-K Silkscreen Probe</p> <p>15' (4.6 m) 3" (76 mm)</p>	<p>Temp. Range: -40° to 400°F (-40° to 205°C) Max Tip/Cable Temp: 400°F (205°C) Response Time: 1 second, in liquid Unit Weight: 3 oz (85 g) Silicone Outer Jacket PTFE Ring Replacement wires, springs and sinkers sold separately (item 10830) Designed to measure actual ink temperatures to profile dryers.</p>
<p>50010 (K or T) Tape Surface Probe</p> <p>36" (914 mm) 1" (25 mm) 1" (25 mm)</p> <p>Cutaway of thermocouple sensor between PTFE tape layers.</p>	<p>Temp. Range: -40° to 400°F (-40° to 205°C) Max Tip/Cable Temp: 400°F (205°C) Response Time: 9 seconds on metal surface Unit Weight: 1 oz (28 g) Flexible Cable with FEP Jacket Can be placed between packs of food or cartons. Also suitable for platens.</p>
<p>50012 (J, K or T) 120° Angled Shaft Surface Bell Probe</p> <p>48" (1.2 m) Extended 12" (305 mm) Retracted 4.25" (108 mm) 4.5" (114 mm) .375" (9.5 mm) 2" (51 mm) .67" (17 mm)</p>	<p>Temp. Range: -40° to 500°F (-40° to 260°C) Max Tip Temp: 500°F (260°C) Max Cable Temp: 176°F (80°C) Max Handle Temp: 325°F (163°C) Response Time: 4 seconds, oiled surface Unit Weight: 5 oz (142 g) Coiled Retractable Cable Designed for use on any flat surface. Bell self-ori-ents to the surface, giving superior contact. Ideal for griddle and platens.</p>



50014 (J, K or T) Weighted Griddle Surface Probe

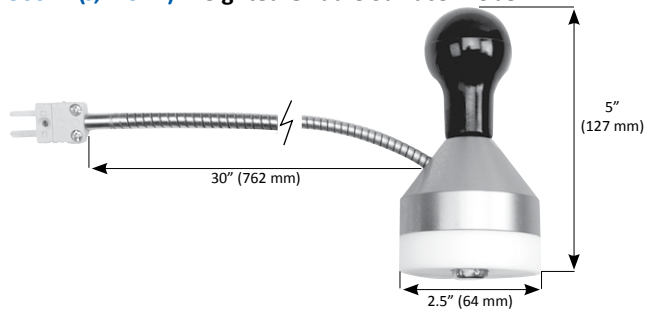

Temp. Range: -40° to 500°F (-40° to 260°C)
 Max Tip Temp: 500°F (260°C)
 Max Cable Temp: 400°F (205°C)
 Max Handle Temp: 325°F (163°C)
 Response Time: 2 seconds, oiled surface
 Unit Weight: 2 lb (907 g)
[Flexible Armored Cable](#)
 Weighted probe allows hands-free use.

50069 (J, K or T) Moving Surface Bow Probe - Replaceable Sensor

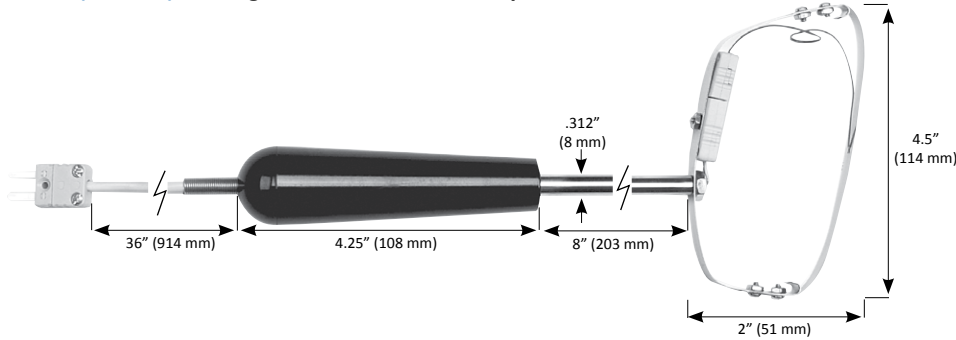

Temp. Range: -40° to 500°F (-40° to 260°C)
 Max Tip Temp: 500°F (260°C)
 Max Cable Temp: 221°F (105°C)
 Max Handle Temp: 325°F (163°C)
 Response Time: 4 seconds, oiled surface
 Replaceable Sensor:
 MD3132-10 (Type K);
 MD3132-8 (Type J)
 MD3132-12 (Type T)
 Unit Weight: 6 oz (170 g)
[Flexible Cable with PVC Jacket](#)
 Designed for moving surfaces and rollers. Gives a more accurate measurement on moving surfaces than a standard surface probe.

50316 (J, K or T) 1/8" Surface / Immersion Probe - Flat Tip

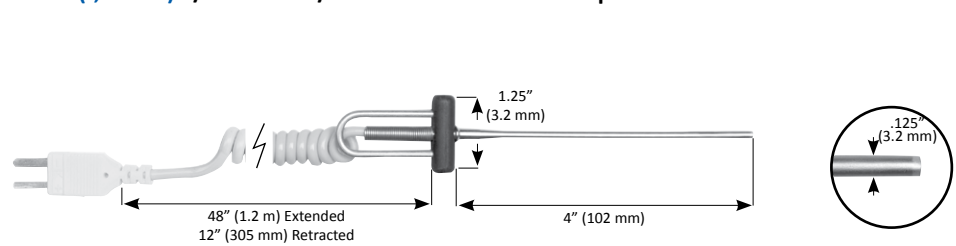

Temp. Range: -100° to 500°F (-73° to 260°C)
 Max Tip Temp: 500°F (260°C)
 Max Cable Temp: 176°F (80°C)
 Max Handle Temp: 280°F (138°C)
 Response Time: 6 seconds, oiled metal surface; 1 second, liquid
 Unit Weight: 2 oz (57 g)
[Coiled Retractable Cable](#)
 This probe has a flat tip for surface temperatures, but is also a very fast immersion probe.
Note: Not recommended for use in highly acidic or alkaline products such as citrus and tomato products.

50318 (J, K or T) Ceramic Tip Surface Probe

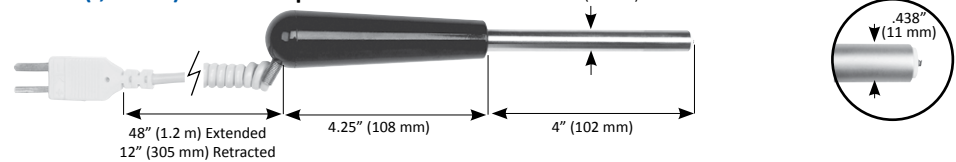

Temp. Range: -40° to 1202°F (-40° to 650°C)
 Max Tip Temp: 1202°F (650°C)
 Max Cable Temp: 176°F (80°C)
 Max Handle Temp: 325°F (163°C)
 Response Time: 1 second, oiled surface
 Unit Weight: 5 oz (141 g)
[Coiled Retractable Cable](#)

50319 (J, K or T) Ceramic Tip Surface Probe - Right Angle

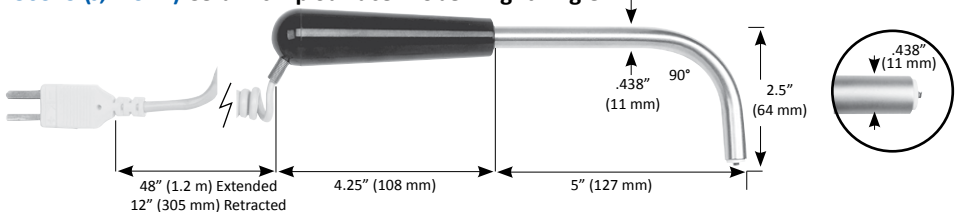

Temp. Range: -40° to 1202°F (-40° to 650°C)
 Max Tip Temp: 1202°F (650°C)
 Max Cable Temp: 176°F (80°C)
 Max Handle Temp: 325°F (163°C)
 Response Time: 1 second, oiled surface
 Unit Weight: 6 oz (170 g)
[Coiled Retractable Cable](#)

50405-K Blunt Tip Probe - Direct Connect

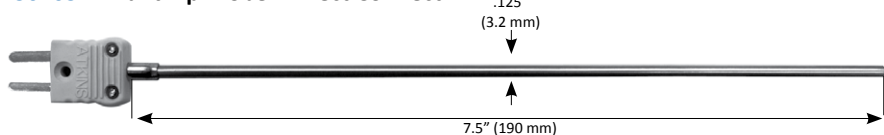

Temp. Range: -100° to 500°F (-73° to 260°C)
 Max Tip Temp: 500°F (260°C)
 Response Time: 6 seconds, oiled surface;
 1 second, liquid
 Unit Weight: .5 oz (14 g)

54011-K Pipe Strap Probe

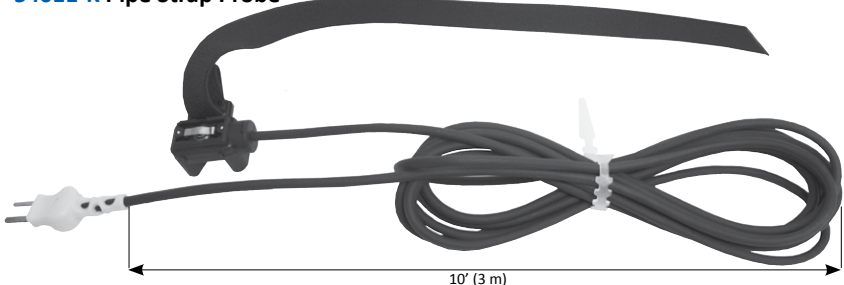

Temp. Range: -25° to 300°F (-32° to 149°C)
 Max Tip Temp: 300°F (149°C)
 Max Cable Temp: 220°F (104°C)
 Unit Weight: 2 oz (57 g)
 Cable Length: 10' (3 m) straight cord
 The special strap-hook design fits up to a 3.3" (84 mm) diameter pipe.
[Polyurethane Cable](#)



MISCELLANEOUS PROBES

Cooper-Atkins manufactures hundreds of different probes for a multitude of uses that can be custom-designed for specific customer needs.

For information on any item not shown or listed here, or if you would like us to design and build probes that are unique to your business, please contact Customer Service at 860-347-2256 or visit www.cooper-atkins.com

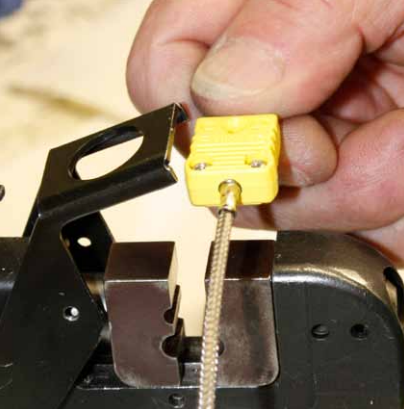

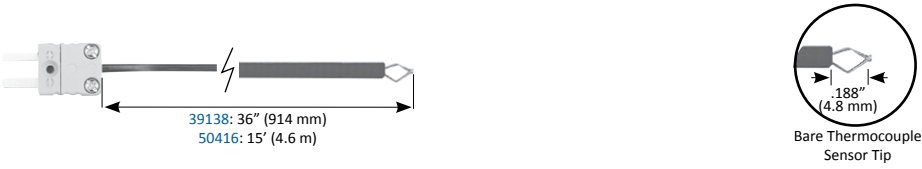
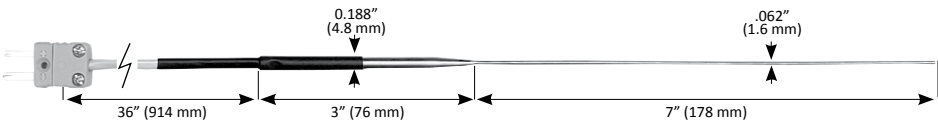
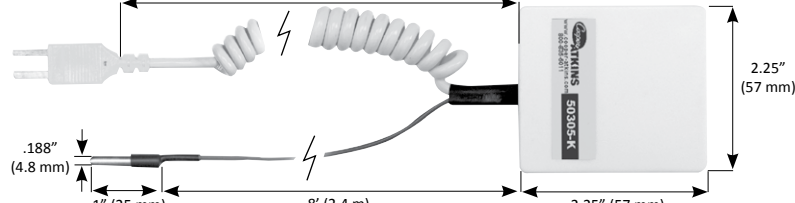
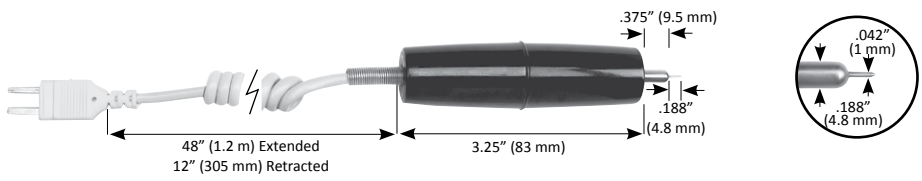
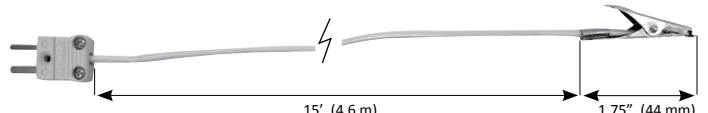
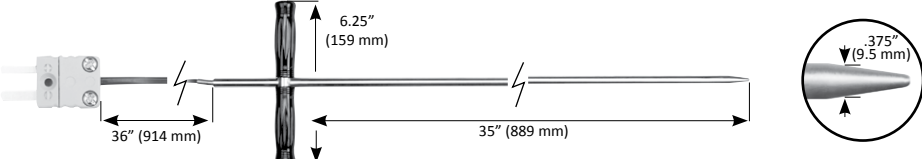
<p>39138 & 50416 (J, K or T) Bare Tip Probe - FEP Cable</p> 	<p>Temp. Range: -328° to 400°F (-200° to 205°C) Max Tip/Cable Temp: 400°F (205°C) Response Time: 1 second, liquid; 7 seconds in 5m/sec. air stream Unit Weight: 1 oz (28 g) Flexible Cable with FEP Jacket</p> <p>Can measure immersion or air temperatures, or can be installed in substrates of surfaces. Can be embedded in products for freezing and heating studies.</p>
<p>49136 (J, K or T) Bendable Tip Probe</p> 	<p>Temp. Range: 32° to 1652°F (0° to 900°C) Max Tip Temp: 1652°F (900°C) Max Cable Temp: 221°F (105°C) Response Time: 1 second, liquid Unit Weight: 1 oz (28 g) Flexible Cable with PVC Jacket</p> <p>MgO filled stainless steel stem is bendable, ideal for air or liquid temperatures in which quick response is desired or higher temperatures are being measured.</p>
<p>50305 (J, K or T) Freezer / Cooler Probe - Mountable 24" (610 mm) Extended / 6" (152 mm) Retracted</p> 	<p>Temp. Range: -40° to 400°F (-40° to 205°C) Max Tip Temp Sensor Cable: 400°F (205°C) Max Coil Cable Temp: 176°F (80°C) Response Time: 25 seconds, air Unit Weight: 3 oz (85 g) Coil Retractable Cable and Sensor Cable with Flexible FEP Jacket</p> <p>Thermocouple Instrument can be plugged into a junction box for quick temperature measurement without opening the freezer or cooler door.</p>
<p>50121 (J, K or T) Racing Tire Probe - Fine Needle Tip</p> 	<p>Temp. Range: -40° to 500°F (-40° to 260°C) Max Tip Temp: 500°F (260°C) Max Cable Temp: 176°F (80°C) Max Handle Temp: 325°F (163°C) Response Time: 1 second, liquid Unit Weight: 4 oz (113 g) Coiled Retractable Cable</p> <p>Tip designed specifically to penetrate soft rubber and to provide fast response times</p>
<p>50415-K Dishwasher Probe</p> 	<p>Temp. Range: -67° to 221°F (-55° to 105°C) Max Tip/Cable Temp: 221°F (105°C) Response Time: 9 seconds in 5m/sec. air stream Unit Weight: 3 oz (85 g) PVC Jacketed Straight Cable</p>
<p>50701-K Combo Probe - Heavy-duty, T-Handle</p> 	<p>Temp. Range: -100° to 500°F (-73° to 260°C) Max Tip Temp: 500°F (260°C) Max Cable Temp: 400°F (205°C) Max Handle Temp: 150°F (65°C) Response Time: 2 seconds, liquid Unit Weight: 15 oz (425 g) Flexible Cable with Fluoroelastomer Jacket</p> <p>The long combo probe is ideal for measuring large cooking kettles, vats or compost.</p>



REPLACEMENT PROBES

FOR AQUATUFF™ THERMOCOUPLE WRAP&STOW™ INSTRUMENTS

Suitable for measuring a variety of different substances from dense solids and meats to delicate products such as eggs and liquids.

Aquatuff™ replacement probes can be changed on location and maintain the Total System Accuracy without calibration. Wrap&Stow™ thermocouple instruments are designed with unique cable storage channels to safely store and protect the probe.



55032 / 55032-N DuraNeedle Probe



Temp. Range: -100° to 500°F (-73° to 260°C)
 Max Tip Temp: 500°F (260°C)
 Max Cable/Handle Temp: 400°F (205°C)
 Response Time: 1 second, liquid
 Unit Weight: 2 oz (57 g)
Flexible Cable with Fluoroelastomer Outer Jacket
 55032-N is the replacement probe for the 35X Series NSF-listed instruments.
 Designed to measure dense meats, soft foods and liquids.

55035 Surface Probe

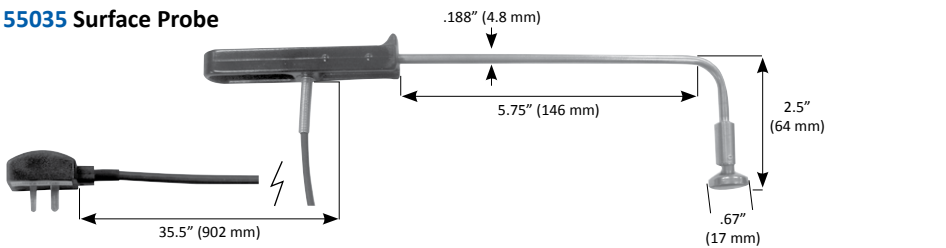

Temp. Range: -40° to 500°F (-40° to 260°C)
 Max Tip Temp: 500°F (260°C)
 Max Cable/Handle Temp: 400°F (205°C)
 Response Time: 2 seconds, oiled surface
 Unit Weight: 3 oz (85 g)
Flexible Cable with Fluoroelastomer Outer Jacket

55040 / 55040-N MicroNeedle Probe

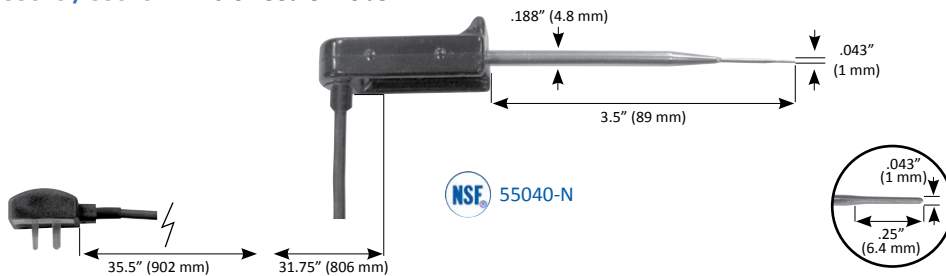

Temp. Range: -100° to 500°F (-73° to 260°C)
 Max Tip Temp: 500°F (260°C)
 Max Cable/Handle Temp: 400°F (205°C)
 Response Time: 1 second, liquid
 Unit Weight: 2 oz (57 g)
Flexible Cable with Fluoroelastomer Outer Jacket
 55040 with more robust spring strain relief, is not NSF listed.
 55040-N is the replacement probe for the 35X Series NSF-listed instruments.

CONNECTORS AND EXTENSION CABLES

Extension cables can be used to increase cable length on any thermocouple probe. Atkins' extension cables can also be used to add a cable to a direct-connect probe.

10040 (J, K or T) Coiled Retractable Extension Cable

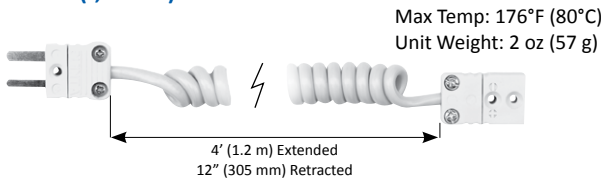

Max Temp: 176°F (80°C)
 Unit Weight: 2 oz (57 g)

10045 / 10052 (J, K or T) Extension Cables, 20 Ga.

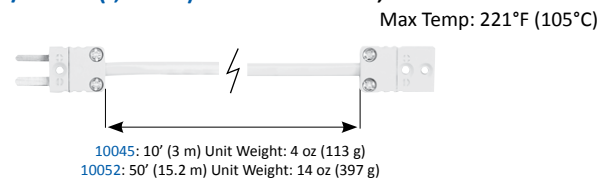

Max Temp: 221°F (105°C)

Miniature Thermocouple Connectors

Male: PD1389-10-K

Female: PD1389-52-K



Unit Weight: 0.1 oz (2.8 g)
 Also available in J or T

10046 / 10051 (J, K or T) Extension Cables

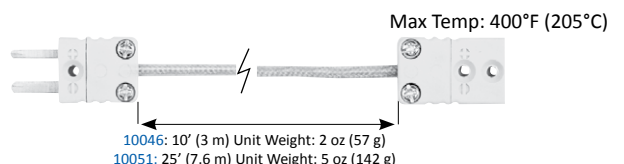









Max Temp: 400°F (205°C)

PROBE INFORMATION

The response time of a thermocouple probe temperature can be graphed as an exponential function. One time constant is defined as the time required to reach 63.2% of the temperature change, two time constants is 86.5% and three is 95% of the temperature change. At Cooper-Atkins, the response time is stated at three time constants of the temperature change. Response times are intended as a general guideline and can differ in actual usage conditions. All testing done at the factory is under controlled conditions.

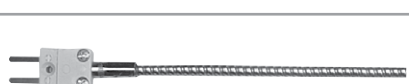
Thermocouple Types: The probe thermocouple Type (J, K, or T) must match that of the thermocouple instrument. Specifications shown in this catalog are for thermocouple Type K models. Probes are also available in thermocouple types J and T (as indicated in the probe tables). In some cases, the upper temperature limits for types J and T may differ from that shown in the catalog. For availability or specifications please contact Customer Service at: 800.835.5011 or 860.347.2256.

PROBE CABLE STYLES

	Flexible Cable with PVC Jacket: PVC insulation on primaries and outer jacket. PVC offers good abrasion and chemical resistance.
	Coiled Retractable Cable: Polyurethane outer jacket. PFA insulation on primaries. Polyurethane offers excellent abrasion resistance and good chemical resistance.
	Flexible Cable with FEP Jacket: FEP insulation on primaries and outer jacket. FEP offers excellent abrasion and chemical resistance.
	Flexible Cable with Fluoroelastomer Jacket: Custom, patented Cooper-Atkins cable with Aramid fillers and metal braid for strength. Fluoroelastomer offers outstanding abrasion and chemical resistance. Connector design for use of Wrap&Stow™ Thermocouple Instruments.
	Flexible Armored Cable: FEP-jacketed cable protected by flexible, stainless steel, armored hose. The armored hose protects the cable and offers outstanding abrasion, cut and chemical resistance.
	Flexible Cable with Silicone Jacket: Silicone outer-jacketed cable with Aramid fillers. Silicone offers good abrasion and chemical resistance.
	Flexible Cable with Woven Stainless Steel Overbraid: Polyimide film insulation on primaries and outer jacket. Cable protected by stainless steel overbraid. Offers outstanding abrasion and cut resistance and good chemical resistance.
	Flexible Cable with Fiberglass Jacket: Woven fiberglass insulation with a resin coating on primaries and outer jacket. Excellent for high temperature applications. Not recommended for abrasive, high-flex or foodservice applications.

Accuracy Tolerances for Standard Thermocouples (A.N.S.I. MC 96.1 - 1982)

Type K Thermocouples

Above 32°F or 0°C: $\pm 0.75\%$ of reading (or $\pm 4^\circ\text{F}$ (2.2°C) whichever is greater) to 2,282°F (1,250°C)
Below 32°F (0°C): $\pm 2.0\%$ of reading (or $\pm 4^\circ\text{F}$ (2.2°C) if greater) to -328°F (-200°C)

Type J Thermocouples

Above 32°F or 0°C: $\pm 0.75\%$ of reading (or $\pm 4^\circ\text{F}$ (2.2°C) whichever is greater) to 1,382°F (750°C)
Below 32°F (0°C): No A.N.S.I. specification.

Type T Thermocouples

Above 32°F or 0°C: $\pm 0.75\%$ of reading (or $\pm 1.8^\circ\text{F}$ (1.0°C) whichever is greater) to 662°F (350°C)
Below 32°F (0°C): $\pm 1.5\%$ of reading (or $\pm 1.8^\circ\text{F}$ (1.0°C) if greater) to -328°F (-200°C)

Cable Information

- Probes with special limits of error cables are available for quote to high volume users.
- Avoid damage by not over-stretching or kinking the probe cables.
- Detach probe from the instrument by holding the plug firmly; do not pull plug out by the cable or damage may result.

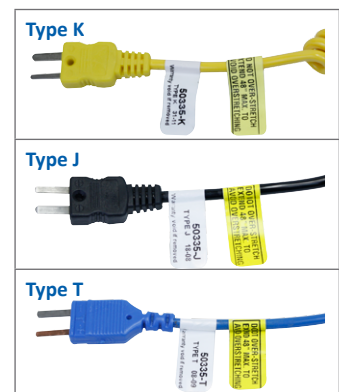

WARRANTY

Atkins' thermocouple instruments and probes are covered by the industry's leading warranty program. They are specifically designed to withstand the rigors of a foodservice or industrial application. This warranty program, combined with over 125 years of manufacturing experience, ensures your instrument will provide many years of reliable service. The quality, features and benefits built into Atkins' Thermocouple instruments and probes offer you the protection of knowing a critical piece of your food safety plan is highly reliable and guaranteed.

Simply stated, you are receiving the highest quality products available and the best overall value of your investment.



All thermocouple instruments are guaranteed to be free of defects in workmanship and materials for five years from date of purchase. You can identify on the AquaTuff™ Instruments the date of manufacture by the serial number located on the back of all models. For EconoTemp™ models, the serial number is located inside the battery compartment.

AquaTuff™ and EconoTemp™ Instruments have a 9-digit code that is followed by the model number. The first two digits represent the month of manufacture, the second two digits represent the day of manufacture, and the third two digits are the year of manufacture (e.g., s/n 031208024-35100-K was manufactured on March 12, 2008).



All probes are guaranteed to be free of defects in workmanship and materials for one year. Our probes have a 4-digit serial number that identifies the time when your probe was manufactured. The serial number is located on the label fastened to the probe cable just below the mini-connector. The first two digits represent the week of the year of manufacture and the second two digits represent the year of manufacture (e.g., s/n 43-07 was manufactured in the week of October 23, 2007).

For more information reference the [Thermocouple Instrument and Probe Warranty Program \(PDF\)](#) located at: www.cooper-atkins.com/documentation.asp



TROUBLESHOOTING

If your thermometer does not appear to be working properly reference the [Thermocouple Instrument Troubleshooting Guide](#) contained in the [Thermocouple Instrument and Probe Warranty Program](#) (see above). If the problem persists and is not resolved using the suggested steps in the troubleshooting guide, please contact our Technical Service Department (see 'SERVICES' below).

Cooper-Atkins Technical Service Department

When you call our Technical Service Centers, a representative will attempt to isolate the problem over the phone. If the problem is clearly isolated to the probe, and the probe was manufactured within the warranty period (12 months), you will be asked to return the probe for further inspection. If they are unable to isolate the problem, you will be asked to return the instrument and the probe for further inspection.

In these cases:

- You will be given a *Return Goods Authorization* (RGA) number to identify the return.
- You will be asked to send the item(s) to our Service Center for evaluation by our Technical Service Centers.
- The item(s) will be serviced as stated below.

SERVICES

If the problem is covered under our warranty terms, the thermocouple instrument or probe will be repaired/replaced in three to five business days and returned to you.

If the problem is not covered by our warranty terms, the Cooper-Atkins Technical Service Department will call you within three to five days of receipt of your instrument to offer the option of repair at the repair price, or ordering a new unit at a discounted price. Based upon your approval, Cooper-Atkins will ship the repaired or replacement instruments and/or probes to you.

Cooper-Atkins Customer Service:
(800) 835-5011 or (860) 347-2256
Email: info@cooper-atkins.com

USA Technical Service Center:
Cooper-Atkins Corporation
33 Reeds Gap Road
Middlefield, CT 06455-0450 U.S.A.
(800) 835-5011
Email: info@cooper-atkins.com

Europe Technical Service Center:
Cooper-Atkins European Service Center
(c/o Blanken Controls)
Imbosweg 30, 7371 DD Loenen
NETHERLANDS
Email: service@cooper-atkins.eu



ACCESSORIES

There are many accessories that Cooper-Atkins provides. Below are just a few items that will assist in cleaning, storing and testing your instruments and probes. Atkins offers a wide range of customization options with an assortment of instruments and probe kits available.



9150 Boxed Probe Wipes

- 2" x 2" (50 cm x 50 cm)
- 200 packets in a box
- 1 Master Carton: 5 lb 8 oz (2495 g)



9152 Large Tub Wipes

- 3" x 4.75" (7.6 cm x 12.1 cm)
- 200 per tub
- 1 Master Carton: 10 lb 4 oz (4649 g)



9325 VALCUP™

Validate the accuracy of your thermometer with our NEW, easy-to-use VALCUP! Just fill with crushed ice, add water, insert thermometer and validate.



9368 Wall-Mount Bracket for EconoTemp™ 323 Thermocouple Series



9369 Wall-Mount Bracket for AquaTuff™ 35X Thermocouple Series



9319/9319C Thermocouple Prover

The Prover tests and validates the calibration accuracy of Type K thermocouple instruments and can simulate three selectable temperatures.

9319

- 32°F, 100°F and 160°F
- ±0.25°F

9319C

- 0°C, 25°C and 60°C
- ±0.14°C

Features:

- Low battery indicator (LED)
- Battery Life 100 hours
- Weight: 2 oz (57 g)

CUSTOMIZATION



Cooper-Atkins Corporation is known for offering exceptional service and innovative quality products. We provide customized kit solutions tailored to the needs of your business. We offer a thermocouple instrument with the assortment of probes of your choice packaged into a storage case to keep them secure. We can also custom manufacture probes for your unique applications.

Carry / Storage Cases:

- 14057 Soft (zippered) Pouch 9" x 3.5" x 2" (23 cm x 9 cm x 5 cm)
- 14235 Medium Case 12" x 8" x 3" (30 cm x 20 cm x 8 cm)
- 14240 Small Case 6" x 8.5" x 2.5" (15 cm x 22 cm x 6 cm)
- 14245-1 Large Case 17" x 12" x 3" (43 cm x 30 cm x 8 cm)
- 9339 Nylon Pouch/Velcro Flap 8.5" x 3.5" x 1" (22 cm x 9 cm x 2.5 cm)

Cooper-Atkins Corporation reserves the right to change specifications without notice.



Printed On Recycled Paper



Cooper-Atkins Corporation
33 Reeds Gap Road, Middlefield, CT 06455 U.S.A.
800-835-5011 • 860-347-2256 • Fax: 860-347-5135
www.cooper-atkins.com

